

# Class 20 Type 1 Diesel Loco

by Ray Morris

00 scale

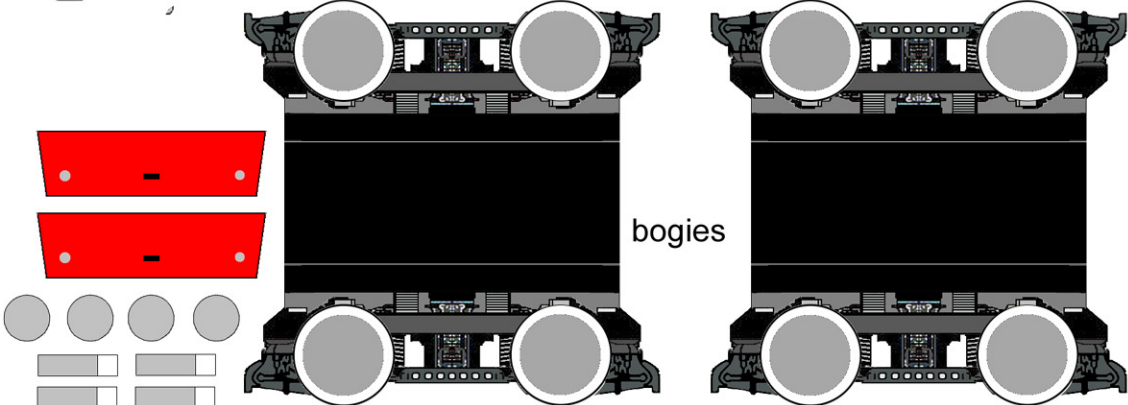
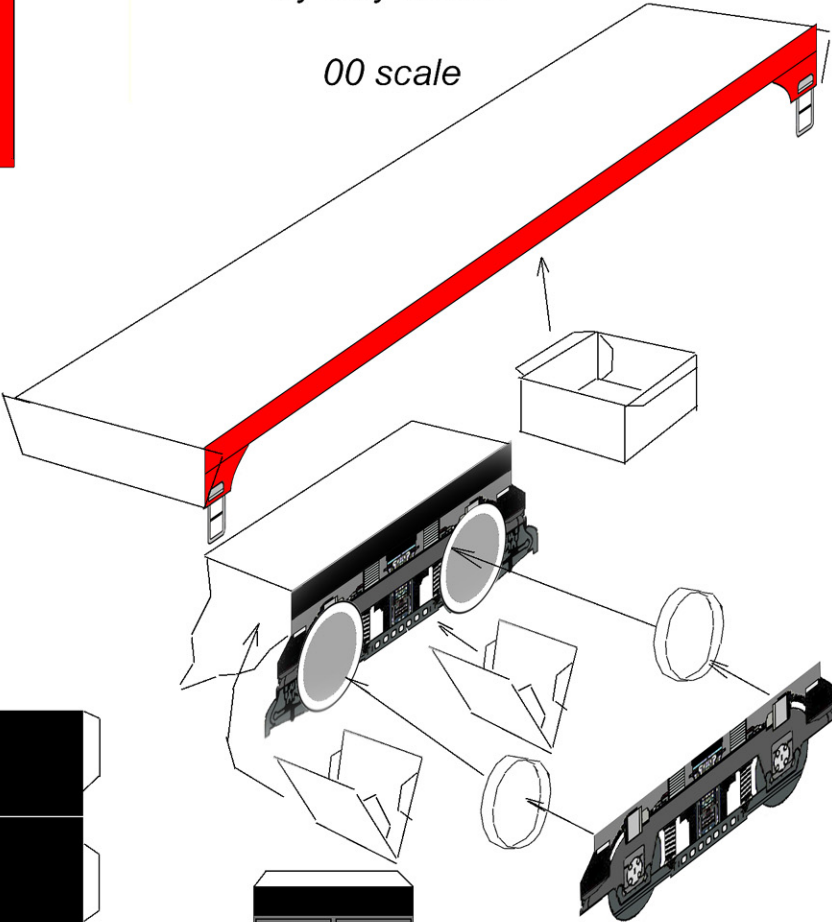
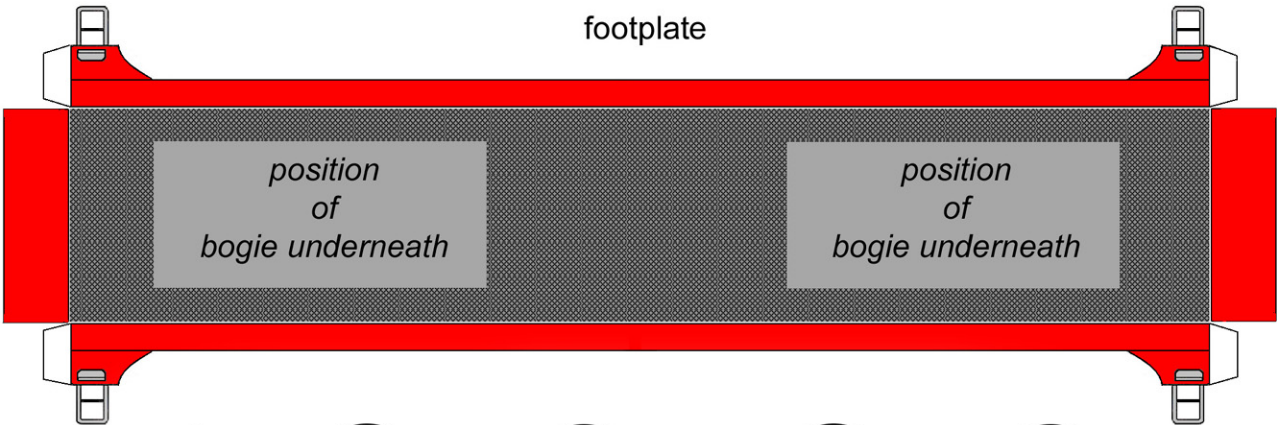

bogies

buffers

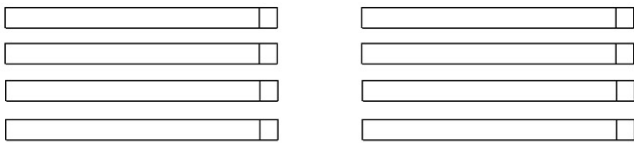

wheel rims

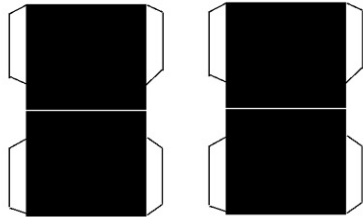
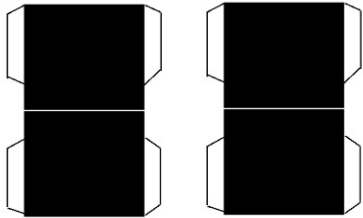

bogie strengthening pieces

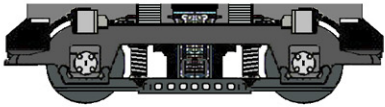
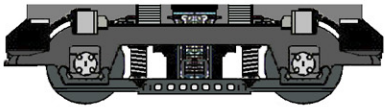

outer bogies

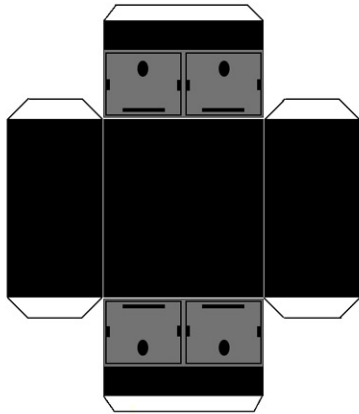
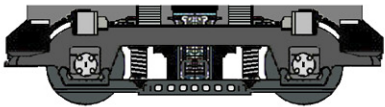

box between bogies